

WOOD | STONE

mantels & surrounds
BY FIRE SIDE FURNISHINGS

Mantels & surrounds **for every décor**
Design Series | Signature Series | Select Series

Mantels & surrounds to fit any style



Battlefield mantel in distressed knotty alder with custom ginger stain and absolute black granite

Design Series

A distinctive selection of mantels, the Design Series is for those with an appreciation for design and craftsmanship who want to stay ahead of today's current trends.



Kenwood mantel with custom paint and beige surround

Signature Series

Timeless and superior in quality, the broad range of mantels in the Signature Series offers designs with something for every décor.



It's in the details

Fireside Furnishings is the premier provider of hearth design solutions for finishing around wood, gas and electric fireplaces. With a broad range of wood mantels and stone selections, the thoughtful details come together to transform a simple fireplace into a beautiful showpiece, and your room into a natural reflection of your dreams, the way you live – your style.

Inspirational ideas for finishing your fireplace can come from all over. Mantels and surrounds by Fireside Furnishings incorporate the best details of traditional, transitional and rustic home furnishing styles.

TRADITIONAL STYLE — Inspired by 18th-century French, English and Italian designs, the traditional finishing options capture the spirit of history in the details.

TRANSITIONAL STYLE — Inspired by Arts and Crafts, Mission, Cottage, Lodge, and Shaker styles, transitional mantel options effortlessly blend designs from traditional to more contemporary.

RUSTIC STYLE — Refreshing simplicity highlighted by natural beauty and rugged charm.

Fireside Furnishings flush wood mantels and shelves are a great value that create a focal point for all rooms. Each is delivered ready to finish with your choice of paint or stain to perfectly match the personal style and décor of your home.

Offering an easy way to create a dramatic impact without dramatic cost, the Select Series is the perfect blend of quality, design and value.

Select Series



Wescott mantel with custom paint and absolute black granite

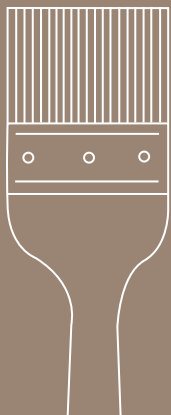

Why unfinished is **the best solution**

YOU'RE IN CONTROL of your color choices from the start.

TAKES AWAY THE GUESSWORK of matching décor or current woodwork in your home.

CUSTOM FINISH IS AVAILABLE Ask your hearth provider for a quote on the different custom stain options.

Four steps to customizing your hearth

1

Choose your style

The Design, Signature and Select Series wood mantels are available in traditional, transitional and rustic styles. Easily find the mantel that is perfect for you by browsing through the pages.

2

Pick your mantel]

Choose from an impressive selection of wood mantel designs available in either primed MDF, unfinished maple or unfinished distressed knotty alder.

3

Match your surround]

Stone selections frame your fireplace to ensure safety clearances are met, and to further enhance the beautiful fire.

4

Finish your hearth

Ready to finish. With the limitless stain and paint colors available, you can customize your mantel to perfectly match your décor and current woodwork.



Wood Species



MDF
PRIMED



MAPLE
UNFINISHED



DISTRESSED KNOTTY ALDER
UNFINISHED

Stone Surrounds

Design Series

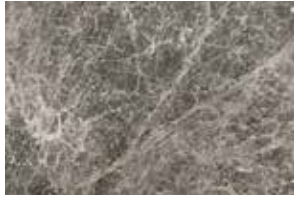

KONYA MARBLE -
LEATHERED SURFACE



BEIGE -
POLISHED SURFACE



MARRON BROWN MARBLE -
POLISHED SURFACE

Signature Series

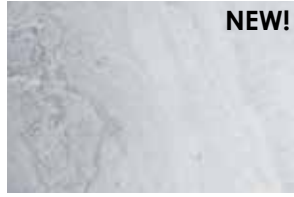

NEW!

ARCTIC GRAY MARBLE -
POLISHED SURFACE



STEEL GRAY GRANITE -
LEATHERED SURFACE

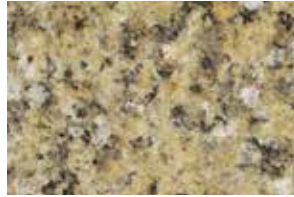

NEW VENETIAN GRANITE -
POLISHED SURFACE



ABSOLUTE BLACK GRANITE -
POLISHED SURFACE



CALEDONIA GRANITE -
POLISHED SURFACE

Select Series



WHEATFIELD GRANITE -
POLISHED SURFACE

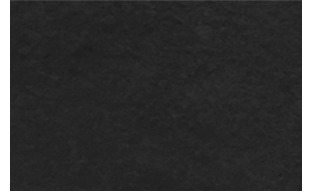

SLATE -
MATTE SURFACE

Stone Sets

The timeless elegance of stone, from the world's finest quarries, is a striking accent to wood mantels. Quality stone facings and hearths are the perfect complement to your fireplace.

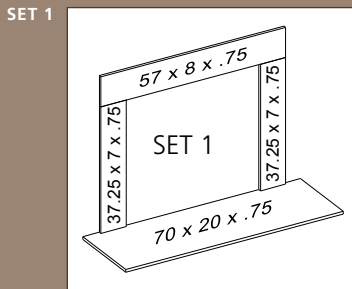

For use with most wood-burning and gas fireplaces

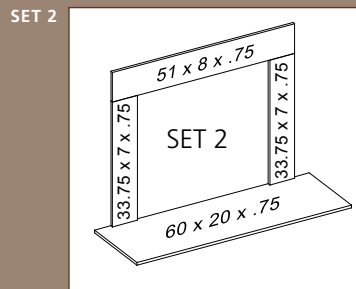

For use with most wood-burning and gas fireplaces

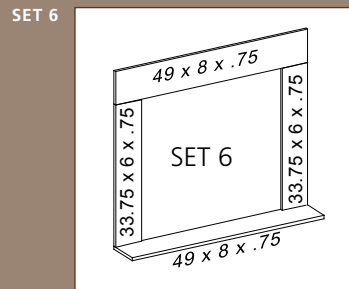

For use with most gas fireplaces

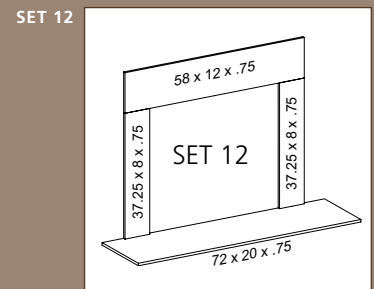

For use when a larger header is required

Stone sets can be cut to fit additional fireplace sizes. Dimensions on all drawings are in inches and for reference only. Please refer to installation manual for detailed specifications on installing this product. Mantel finishes and facing colors are only a representation of the finished look and may not be an exact color match.



Flush Wood Mantels

Capture your unique style by framing your fireplace with a well-crafted **FLUSH WOOD MANTEL** coordinated with beautiful stone. Create a warm, welcoming space in your home that showcases your style.

BELLEVUE *Design Series*



- TRANSITIONAL STYLE
- SHOWN WITH CUSTOM EBONY STAIN AND CALEDONIA GRANITE

Available in:

MDF
PRIMED

MAPLE
UNFINISHED

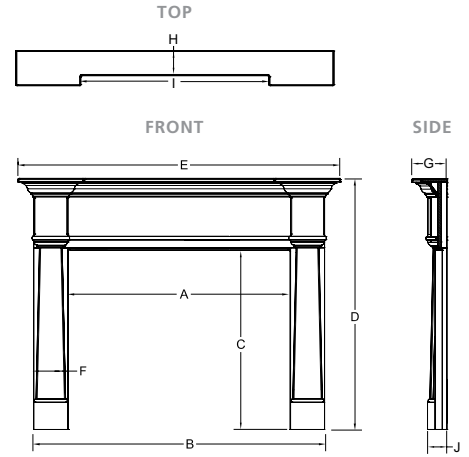

Bellevue	A OPENING WIDTH	B OUTSIDE WIDTH	C OPENING HEIGHT	D OUTSIDE HEIGHT	E TOP WIDTH	F LEG WIDTH	G OUTSIDE SHELF DEPTH	H SHELF INSET DEPTH	I SHELF INSET WIDTH	J LEG DEPTH	K RECOMMENDED SET SIZE
B SIZE	48"	64"	39-1/2"	55-1/4"	71"	6-1/2"	7-3/4"	5-1/2"	42"	3-3/4"	1
C SIZE	53"	69"	42"	57-3/4"	76"	6-1/2"	7-3/4"	5-1/2"	47"	3-3/4"	1

BATTLEFIELD *Design Series*



- RUSTIC STYLE
- SHOWN WITH CUSTOM GINGER STAIN AND NEW VENETIAN GRANITE

Available in:

MDF
PRIMED

MAPLE
UNFINISHED

**DISTRESSED
KNOTTY ALDER**
UNFINISHED

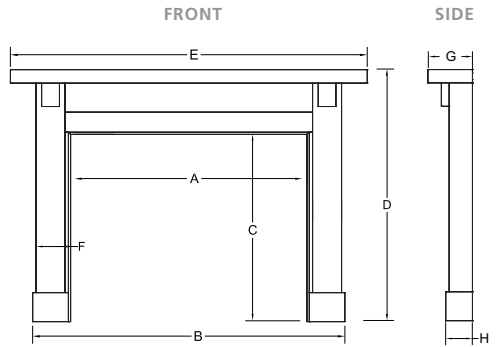

Battlefield	A OPENING WIDTH	B OUTSIDE WIDTH	C OPENING HEIGHT	D OUTSIDE HEIGHT	E TOP WIDTH	F LEG WIDTH	G SHELF DEPTH	H LEG DEPTH	I RECOMMENDED SET SIZE
B SIZE	48"	65"	39-1/2"	54"	75"	6-1/2"	9"	5-1/4"	1
C SIZE	53"	70"	42"	56-1/2"	80"	6-1/2"	9"	5-1/4"	1

PORTICO *Design Series*



Available in:

- MDF**
PRIMED
- MAPLE**
UNFINISHED

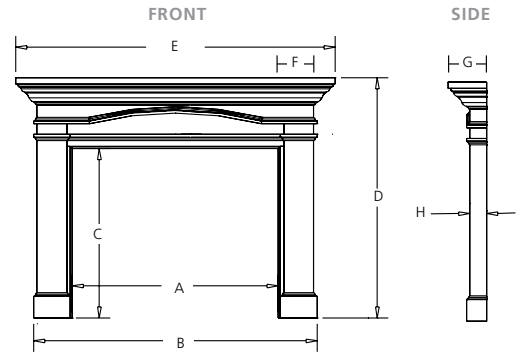

- TRANSITIONAL STYLE
- PORTICO MANTEL SHOWN WITH CUSTOM NATURAL STAIN AND MARRON BROWN MARBLE

Portico	A OPENING WIDTH	B OUTSIDE WIDTH	C OPENING HEIGHT	D OUTSIDE HEIGHT	E TOP WIDTH	F LEG WIDTH	G SHELF DEPTH	H LEG DEPTH	I RECOMMENDED SET SIZE
B SIZE	48"	66"	39-1/2"	56"	74-1/2"	8-1/2"	9"	4"	1
C SIZE	53"	70"	42"	59"	78-1/2"	8"	9"	4"	1

ACADIA *Signature Series*



Available in:

- MDF**
PRIMED
- MAPLE**
UNFINISHED

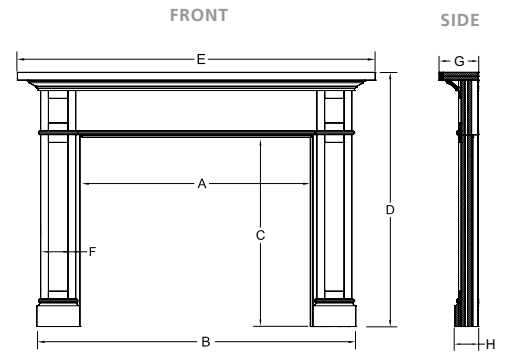

- TRADITIONAL STYLE
- SHOWN WITH CUSTOM PAINT AND ARCTIC GRAY

Acadia	A OPENING WIDTH	B OUTSIDE WIDTH	C OPENING HEIGHT	D OUTSIDE HEIGHT	E TOP WIDTH	F LEG WIDTH	G SHELF DEPTH	H LEG DEPTH	I RECOMMENDED SET SIZE
A SIZE	44"	61-1/2"	36-1/2"	49"	69"	6-3/4"	7-1/2"	3-3/4"	1
B SIZE	48"	65-1/2"	39-1/2"	52"	73"	6-3/4"	7-1/2"	3-3/4"	1
C SIZE	53"	70"	42"	54-1/2"	78"	6-3/4"	7-1/2"	3-3/4"	12

KENWOOD *Signature Series*



- TRANSITIONAL STYLE
- SHOWN WITH CUSTOM PAINT AND ABSOLUTE BLACK GRANITE

Available in:

MDF
PRIMED

MAPLE
UNFINISHED

*kenwood
mantel*

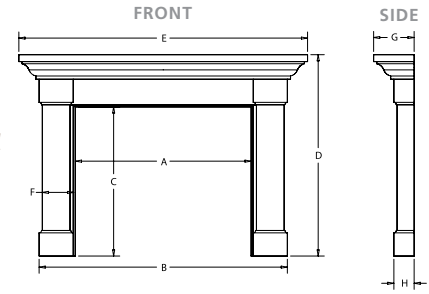

*optional
base*

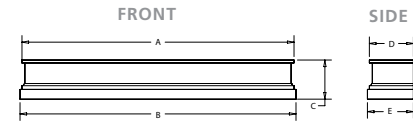

Optional Base	A TOP WIDTH	B BOTTOM WIDTH	C HEIGHT	D TOP DEPTH	E BOTTOM DEPTH
A SIZE	62-3/4"	63-3/4"	10"	11-1/4"	11-3/4"
B SIZE	69-1/2"	70-1/2"	10"	11-1/4"	11-3/4"
C SIZE	74"	75"	10"	11-1/4"	11-3/4"

Kenwood (Without Base)	A OPENING WIDTH	B OUTSIDE WIDTH	C OPENING HEIGHT	D OUTSIDE HEIGHT	E TOP WIDTH	F LEG WIDTH	G SHELF DEPTH	H LEG DEPTH	I RECOMMENDED SET SIZE
A SIZE	44"	60"	36-1/2"	48-3/4"	69-1/2"	8"	9-3/4"	5"	6
B SIZE	48"	65"	39-1/2"	51-3/4"	74-1/2"	8"	9-3/4"	5"	1
C SIZE	53"	70"	42"	54-1/4"	79-1/2"	8"	9-3/4"	5"	1
B60 SIZE	46"	60"	39-1/2"	51-5/8"	67-1/2"	5"	8-1/2"	4"	2

ROXBOROUGH *Signature Series*



- TRADITIONAL STYLE
- SHOWN WITH CUSTOM PAINT AND CALEDONIA GRANITE

Available in:

MDF
PRIMED

MAPLE
UNFINISHED

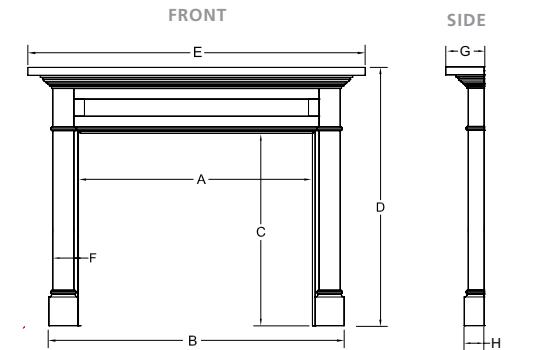

Roxborough	A OPENING WIDTH	B OUTSIDE WIDTH	C OPENING HEIGHT	D OUTSIDE HEIGHT	E TOP WIDTH	F LEG WIDTH	G SHELF DEPTH	H LEG DEPTH	I RECOMMENDED SET SIZE
A SIZE	44"	56"	36-1/2"	49"	64"	4"	7-1/4"	3"	2
B SIZE	48"	60"	39-1/2"	52"	68"	4"	7-1/4"	3"	2
C SIZE	53"	65"	42"	54-1/2"	73"	4"	7-1/4"	3"	1

WESCOTT *Select Series*



- TRANSITIONAL STYLE
- SHOWN WITH CUSTOM PAINT AND KONYA MARBLE

Available in:
MDF
PRIMED

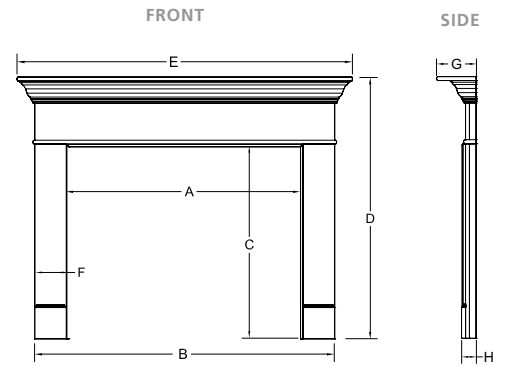

Wescott	A OPENING WIDTH	B OUTSIDE WIDTH	C OPENING HEIGHT	D OUTSIDE HEIGHT	E TOP WIDTH	F LEG WIDTH	G SHELF DEPTH	H LEG DEPTH	I RECOMMENDED SET SIZE
A SIZE	44"	57"	36-1/2"	49-3/4"	63-3/4"	6"	7-1/2"	2-3/4"	2
B SIZE	48"	60"	39-1/2"	52-3/4"	66-3/4"	5-1/2"	7-1/2"	2-3/4"	2
C SIZE	53"	66"	42"	55-1/4"	72-1/2"	6"	7-1/2"	2-3/4"	1

RICHLAND *Select Series*



- TRANSITIONAL STYLE
- SHOWN WITH CUSTOM PAINT AND STEEL GRAY GRANITE

Available in:
MDF
PRIMED

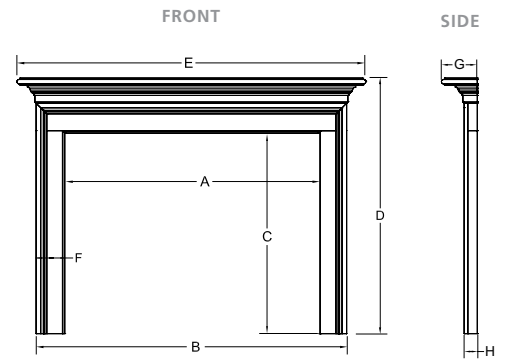

Richland	A OPENING WIDTH	B OUTSIDE WIDTH	C OPENING HEIGHT	D OUTSIDE HEIGHT	E TOP WIDTH	F LEG WIDTH	G SHELF DEPTH	H LEG DEPTH	I RECOMMENDED SET SIZE
RS SIZE	44"	55"	36-1/2"	48"	60"	5"	7-1/2"	2-3/4"	6
A SIZE	44"	56"	36-1/2"	48"	64"	5-1/2"	7-1/2"	2-3/4"	6
B SIZE	48"	60"	39-1/2"	51"	68"	5-1/2"	7-1/2"	2-3/4"	6
C SIZE	53"	65"	42"	53-1/2"	73"	5-1/2"	7-1/2"	2-3/4"	1



Wood Shelf Mantels

The **SHELF MANTEL** is the perfect accent to a brick fireplace and a place to showcase some of your most cherished mementos. Available either in 48, 59 or 72-inch lengths.*

OZARK *Design Series*



- RUSTIC STYLE
- SHOWN WITH CUSTOM EBONY STAIN
- AVAILABLE IN 48", 59" AND 72" WIDTHS

Available in:

MDF
PRIMED

MAPLE
UNFINISHED

DISTRESSED
KNOTTY ALDER
UNFINISHED

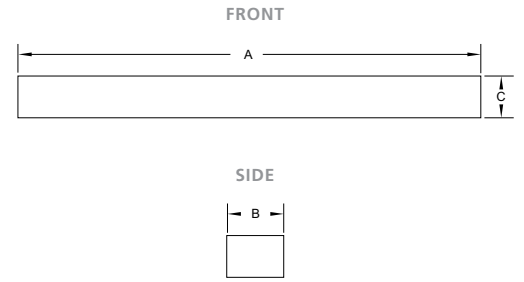

Ozark	A WIDTH	B SHELF DEPTH	C SHELF HEIGHT
SIZE	48"	8"	5"
SIZE	59"	8"	5"
SIZE	72"	8"	5"

GIFFORD *Signature Series*



- TRANSITIONAL STYLE
- SHOWN WITH CUSTOM PAINT
- AVAILABLE IN 48", 59" AND 72" WIDTHS

Available in:

MDF
PRIMED

MAPLE
UNFINISHED

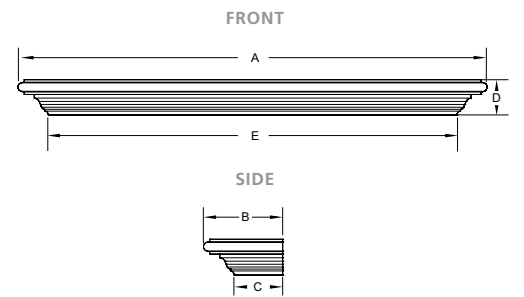

Gifford	A WIDTH	B SHELF DEPTH	C DEPTH	D HEIGHT	E BOTTOM WIDTH
SIZE	48"	8"	4-3/4"	3-5/8"	41-1/2"
SIZE	59"	8"	4-3/4"	3-5/8"	52-1/2"
SIZE	72"	8"	4-3/4"	3-5/8"	65-1/2"

FILLMORE *Select Series*



- TRADITIONAL STYLE
- SHOWN WITH CUSTOM EBONY STAIN
- AVAILABLE IN 48", 59" AND 72" WIDTHS

Available in:

MDF
PRIMED

MAPLE
UNFINISHED

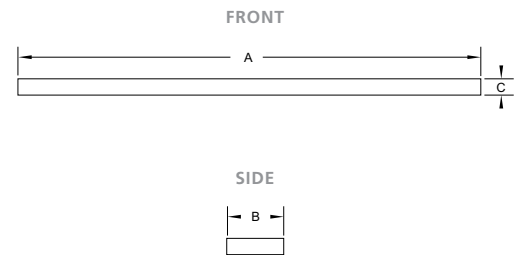

Fillmore	A WIDTH	B SHELF DEPTH	C HEIGHT
SIZE	48"	8"	2-1/2"
SIZE	59"	8"	2-1/2"
SIZE	72"	8"	2-1/2"

CORBELS



- ADDED SUPPORT AND STYLE FOR ANY FIRESIDE FURNISHINGS SHELF
- SHOWN WITH CUSTOM NATURAL STAIN

Available in:

MDF
PRIMED

MAPLE
UNFINISHED

DISTRESSED
KNOTTY ALDER
UNFINISHED

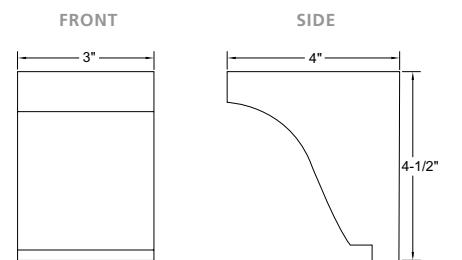



Wood Cabinets

Don't be afraid to think beyond the traditional flush fireplace installation. A **CORNER OR FLAT WALL CABINET** is a great way to add a fireplace with minimal construction. Frame your fireplace perfectly and add a more dramatic look to your room.

KENWOOD CORNER CABINET *Signature Series*



Available in:

MDF
PRIMED

MAPLE
UNFINISHED

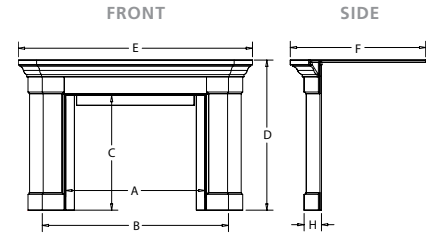
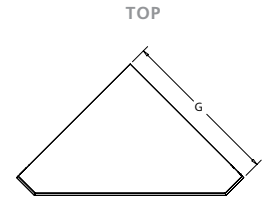

- TRANSITIONAL STYLE
- SHOWN WITH CUSTOM PAINT AND KONYA MARBLE

Kenwood Corner (Without Base)	A OPENING WIDTH	B OUTSIDE WIDTH	C OPENING HEIGHT	D OUTSIDE HEIGHT	E TOP WIDTH	F TOP DEPTH	G SHELF DEPTH (ALONG WALL)	H LEG DEPTH	I RECOMMENDED SET SIZE
43HB	43"	58-1/2"	38-1/4"	50-1/2"	71-11/16"	40-5/32"	50-11/16"	6-1/8"	6
44SB	42"	59-1/8"	36-1/2"	48-11/16"	74-21/32"	43-5/8"	52-25/32"	8-29/32"	6
48DB	48"	60"	39-1/2"	51-11/16"	80-21/32"	46-5/8"	57-1/32"	8-29/32"	6

KENWOOD CORNER CABINET OPTIONAL BASE *Signature Series*



Available in:

MDF
PRIMED

MAPLE
UNFINISHED

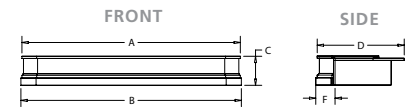
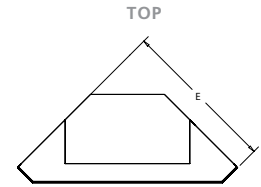

- TRANSITIONAL STYLE
- SHOWN WITH CUSTOM PAINT AND ABSOLUTE BLACK GRANITE

Kenwood Corner Optional Base	A TOP WIDTH	B BOTTOM WIDTH	C HEIGHT	D TOP DEPTH	E SHELF DEPTH (ALONG WALL)	F BASE RETURN
43HB	67-3/32"	67-13/16"	10"	26"	47-7/16"	4-31/32"
44SB	69-13/16"	70-1/2"	10"	30"	49-3/8"	7-3/4"
48DB	75-13/16"	76-1/2"	10"	30"	53-19/32"	7-3/4"

KENWOOD WALL CABINET *Signature Series*



Available in:

MDF
PRIMED

MAPLE
UNFINISHED

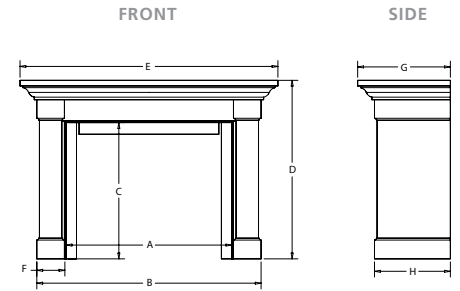

- TRANSITIONAL STYLE
- SHOWN WITH CUSTOM PAINT AND MARRON BROWN MARBLE

Kenwood Wall Cabinet	A OPENING WIDTH	B OUTSIDE WIDTH	C OPENING HEIGHT	D OUTSIDE HEIGHT	E TOP WIDTH	F LEG WIDTH	G SHELF DEPTH	H LEG DEPTH	I RECOMMENDED SET SIZE
43HB	43"	60"	38-1/4"	50-1/2"	69-3/4"	8"	29-5/8"	24-3/4"	6
44SB	42"	59"	36-1/2"	48-3/4"	68-3/4"	8"	26-7/8"	22"	6
48SB	48"	65"	39-1/2"	51-3/4"	74-3/4"	8"	26-7/8"	22"	6
48DB	48"	65"	39-1/2"	51-3/4"	74-3/4"	8"	31-5/8"	26-3/4"	6

KENWOOD WALL CABINET OPTIONAL BASE *Signature Series*



Available in:

MDF
PRIMED

MAPLE
UNFINISHED

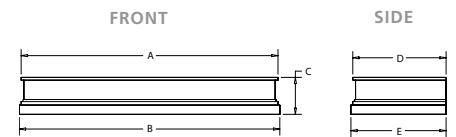

- TRANSITIONAL STYLE
- OPTIONAL BASE SHOWN WITH KENWOOD WALL CABINET IN CUSTOM PAINT AND WHEATFIELD GRANITE

Kenwood Wall Optional Base	A TOP WIDTH	B BOTTOM WIDTH	C HEIGHT	D TOP DEPTH	E BOTTOM DEPTH
43HB	64-1/2"	65-1/2"	10"	28"	28-1/2"
44SB	63-1/2"	64-1/2"	10"	25-1/4"	25-3/4"
48SB	69-1/2"	70-1/2"	10"	25-1/4"	25-3/4"
48DB	69-1/2"	70-1/2"	10"	30"	30-1/2"

Custom Stain Options

All flush wood mantels and surrounds by Fireside Furnishings are available in paint-grade primed MDF or unfinished maple. Select models are available in unfinished distressed knotty alder. Unfinished mantels are delivered ready to be finished with your choice of paint or stain, or can be stained before shipping. Your mantel provider can supply you with details on price and lead times of the available custom stain options.

	<i>Natural</i>	<i>Ginger</i>	<i>Ebony</i>	<i>Chocolate</i>	<i>Ash</i>
<i>Maple</i>					
<i>Distressed Knotty Alder</i>					



www.fireplaces.com

FOR COMPLETE INFORMATION AND VALUABLE ASSISTANCE
ON THESE MANTELS & SURROUNDS, CONTACT US AT: